

**TOWER AND GROUND SPACE LEASE**

This lease, dated this \_\_\_\_\_ day of \_\_\_\_\_, 20\_\_\_\_, is by and between the COUNTY OF ALBEMARLE, a political subdivision of the Commonwealth of Virginia, whose principal address is 401 McIntire Road, Charlottesville, Virginia 22902-4579, hereinafter referred to as "Lessor," and USCOC OF VIRGINIA RSA #3, INC., a Virginia corporation with its principal place of business at Attention: Real Estate Lease Administration, 8410 West Bryn Mawr Avenue, Chicago, Illinois 60631, hereinafter referred to as "Lessee."

**WITNESS:**

**WHEREAS**, the Lessor and Lessee were parties to a Tower and Ground Space Lease from July 1, 2008 to June 30, 2013 (the "Original Lease"), an Addendum to the Original Lease for the term of July 1, 2013 to June 30, 2018 (the "First Addendum"), and a Second Addendum to the Original Lease for the term of July 1, 2018 to June 30, 2023 (the "Second Addendum"), and desire to enter into a new tower and ground space lease.

**WHEREAS**, the Lessor is the owner of certain real property in the Buck's Elbow area of Albemarle County which has an existing communications tower erected on it and existing communications equipment owned by Lessee; and

**WHEREAS**, the Lessee desires to lease a portion of the property, including some space on the tower.

**NOW THEREFORE**, in consideration of the mutual promises, conditions and other good and valuable consideration of the parties hereto, it is covenanted and agreed as follows:

**1. Property.** The Lessor is the owner of certain property, hereinafter referred to as the "Property," located in the County of Albemarle, Virginia, identified as the "Tower Site" on Exhibit A, which is attached hereto and incorporated herein by reference. Lessor also is the owner of a 150-foot telecommunications tower, hereinafter referred to as the "Tower," which is located on the Property. The portion of the Property that has been used by Lessee for its telecommunications facility, hereinafter referred to as the "Site," is depicted on Exhibit A, which is attached hereto and incorporated herein by reference. The demised premises referred to in Section 2 are located within the Site.

**2. Demise of Premises.** Lessor hereby lets and demises unto Lessee, and Lessee hereby receives and accepts from Lessor, the following described Premises:

"Tower Space": Attachment locations on the Tower located on the Site for the placement and affixing of: Four (4) approximately 8' panel antennas, 1 Rad Center approximately 102' above ground level, and Eight (8) lines (1-5/8" coaxial cable), and attachment locations for the placement and affixing of one (1) Eight (8') foot microwave dish, 1 Rad Center approximately 75' above ground level and lines (EW-65 coaxial cable), and additional attachment locations on the Tower as authorized by the Lessor in writing.

"Ground Space": 240 square feet of ground space at the Site, adjacent to the base of the Tower for the placement of a radio station concrete equipment shelter ("Lessee's Building") approximately 20' X 12', one generator, and a line bridge structure.

"Access Easement": A nonexclusive easement over the Site, measuring approximately 99 feet in width and 98 feet in length for ingress and egress extending across the Property, which easement shall be for the purposes described herein.

"Utility Easement": An easement for utility lines and related appurtenances extending between the Site and suitable utility company service points.

The Tower Space, Ground Space, Access Easement and Utility Easement are collectively referred to hereinafter as the "Premises," and each shall be located on the Site as shown on Exhibit A.

**3. Use of the Premises.** Lessee shall be entitled, at Lessee's sole expense, to use and occupy the Premises for the commercial purpose of affixing, installing, operating and/or maintaining four cellular antennas and one microwave antenna on the Tower Space, an access road on the Access Easement, an equipment building on the Ground Space, and a security fence around the perimeter of the Premises, together with all necessary lines, anchors, connections, conduits, devices, and equipment for the transmission, reception, encryption, and translation of voice and data signals by means of radio frequency energy and landline carriage, as shown on Exhibit A.

**4. Term.** The term of this Lease shall be five (5) years, commencing on July 1, 2023 and expiring on June 30, 2028 (the "Original Term").

**5. Extensions of Term.** The parties acknowledge that it is their intent to extend the lease for two (2) additional, five (5) year terms upon the following conditions:

(a) The conditions and provisions contained in this lease will be the basis for any lease amendment executed for a renewal term, except for the rental terms in Section 7.

(b) The annual rent and annual percentage increase in rent for each renewal term will be determined by the parties prior to the renewal term to reflect then existing market conditions (fair market value). Fair market value will be determined by a third-party appraiser to be mutually agreed upon by the parties.

(c) Written notice of intent to renew must be provided by Lessee to Lessor no later than ninety (90) days prior to the expiration of the current term.

(d) Notwithstanding the provisions of this section, neither party is bound to accept a renewal term.

(e) Neither the original nor any renewal term of this Lease shall be established without the express written consent of the Lessor.

All references in this Lease to the "term" of this Lease shall be deemed to include the original term hereof and any and all extensions thereof pursuant to this Section.

**6. Option to Terminate.** Lessee shall have the unilateral right to terminate this Lease at any time by giving written notice to Lessor of Lessee's exercise of this option and paying to Lessor as liquidated damages an amount equal to one year of rent at the time of termination. These liquidated damages are for Lessor's damages resulting from the termination of the Lease only, and by Lessor's acceptance thereof, Lessor does not waive any right or remedy it may have against Lessee arising from any default by Lessee as described in Section 16 of the Lease, from any damage caused by Lessee to the Property or any improvements thereon, or from Lessee's failure to remove its property and/or restore the property if requested to do so by Lessor, as provided in Section 24.

**7. Rent.**

7.1. Original Term Rent. Rent for Year One of the Original Term, beginning July 1, 2023 and ending June 30, 2024, shall be as shown below. In Years Two, Three, Four and Five, rent shall increase annually by three (3) percent, also as shown below:

Term	Rent
Year 1 (7/1/23-6/30/24)	\$37,685.76
Year 2 (7/1/24-6/30/25)	\$38,816.33
Year 3 (7/1/25-6/30/26)	\$39,980.82
Year 4 (7/1/26-6/30/27)	\$41,180.25
Year 5 (7/1/27-6/30/28)	\$42,415.65

7.2. Submission of Rent. Rent shall be due annually on the first day of each Lease year (July 1). Payment shall be made to the County of Albemarle, Department of Finance, 401 McIntire Road, Charlottesville, Virginia 22902-4579, and the payment shall identify that it is for the Buck's Elbow Tower and Ground Space Lease, and state the date of this Lease.

**8. Maintenance.**

8.1. Maintenance of the Tower. Lessor shall, at Lessor's expense, keep the Tower in good condition and repair, and include the Tower in a regular regime of inspection and maintenance. In the event that the condition of the Tower is such that Lessee is unable to transmit, receive, encrypt and translate voice and data signals by means or radio frequency energy and landline carriage from the Site, and such condition is the result of Lessor's failure to keep the Tower in good condition and repair, Lessor shall, upon receipt of notice from Lessee of such inability, promptly make necessary repairs to restore Lessee's ability to provide such services. In the alternative, Lessor may authorize Lessee to make such necessary repairs by written agreement which shall, among other things, specify the work to be performed and the cost therefor. Notwithstanding the foregoing, Lessee may effectuate emergency repairs to the Tower with the prior authorization of Lessor, who shall reimburse Lessee for the reasonable cost for such repairs. Lessor shall not unreasonably withhold such prior authorization.

8.2. Maintenance and Replacement of Equipment. Lessee shall keep all of its antennas, lines, anchors, connections, conduits, devices, and other equipment located on the Tower in good condition and repair. All trash and unwanted debris shall be properly disposed of and removed from the premises. Lessee shall remove any propane tanks from the Premises no later than 60 days after execution of this Lease. Lessee may maintain and repair any lines, anchors, connections, devices or equipment without prior consent of the Lessor.

Lessee shall not add any antennas to the Tower, or relocate its antennas, without the prior written consent of Lessor, which consent shall not be unreasonably withheld or delayed. Lessee shall not add or relocate any antennas, lines, anchors, connections, devices or equipment without the prior written consent of Lessor, which consent shall not be unreasonably withheld or delayed. In addition, prior to replacing any currently existing equipment or antennas with new or modified equipment, Lessee shall conduct a structural analysis of the tower, at its sole expense, to ensure that any newly placed equipment will not impair the structural integrity of the tower and provide a copy of the structural analysis report

to Lessor. Lessee shall submit to Lessor the names and proposals of three (3) contractors qualified to perform that work for selection by Lessor.

**9. Aviation Hazard Marking.** Lessor shall, at Lessor's sole cost and expense, comply at all times with the Tower marking, lighting, recording and notification requirements of the Federal Communications Commission and the Federal Aviation Administration.

**10. Utilities.** Lessor shall cooperate with Lessee in any efforts made by Lessee to obtain utility services at the Site for Lessee's intended use. Lessee shall be responsible for the separate metering, billing, and payment of its utility consumption by its operation.

**11. Taxes.** Lessee shall pay all personal property taxes levied against Lessee's Building and Lessee's base station equipment. Lessor shall claim any exemption from real and personal property taxes to which Lessor is entitled.

**12. Compliance with Laws.** Lessee, shall, at Lessee's cost and expense, comply with all federal, state, county or local laws, rules, regulations and ordinances now or hereafter enacted by any governmental authority or administrative agencies having jurisdiction over the Premises and Lessee's operations thereupon.

**13. Indemnification.** Lessee shall indemnify and hold Lessor harmless from and against any loss, damage, or injury caused by, or on behalf of, or through the fault of Lessee, its officers, employees and agents. Nothing in this Section shall require Lessee to indemnify and hold Lessor harmless from and against any loss, damage, or injury caused by, or on behalf of, or through the fault of Lessor its officers, employees and agents.

**14. Insurance.** Lessee shall continuously maintain in full force and effect a policy of commercial general liability insurance with limits of not less than One Million Dollars covering Lessee's work and operations upon the Property. Lessee shall name the "County of Albemarle, its officers, agents, employees and volunteers" as additional insureds and, within five days of the execution of this Lease, shall provide to Lessor a certificate of insurance so stating.

**15. Interference.** Lessee's base station shall be installed and operated in a manner which does not cause interference to the operations of any Protected Users. "Protected User" shall mean any user of the Site and the Tower whose claimed protected operations chronologically predate Lessee's accused offending operations. Lessee agrees to immediately cure any such interference or, if such interference cannot immediately be cured, to temporarily reduce power or cease the offending operations, if so demanded by Lessor on the ground of interference, until a cure at full power is achieved. Lessor covenants to use Lessor's best efforts to protect Lessee from interference caused or potentially caused by subsequent users of changes in use.

**16. Default.** If Lessor or Lessee fails to comply with any provisions of this Lease which the other party claims to be a default hereof, the party making such claim shall serve written notice of such default upon the defaulting party, whereupon a grace period of thirty (30) days shall commence to run during which the defaulting party shall undertake and diligently pursue a cure of default. The grace period shall automatically be extended for an additional thirty (30)

days, provided the defaulting party makes a good faith showing that efforts toward a cure are continuing.

17. **Quiet Enjoyment.** Lessor hereby covenants that Lessee shall have quiet and peaceful enjoyment of the Premises throughout the lease term as long as Lessee is not in default hereunder.

18. **Title, Access and Authority.** Lessor covenants and warrants to Lessee that Lessor presently owns the fee simple interest in and to the Property; that Lessor is duly authorized and empowered to enter into this Lease; and that the person executing this lease on behalf of the Lessor warrants himself to be duly authorized to bind the Lessor hereto.

19. **Assignment of Lessee's Interest.** Lessee's interest under this Lease may be freely assigned in connection with the transfer of the Federal Communications Commission authorization to operate a cellular common carrier mobile radio telephone communications system, so that the name and identity of the holder of Lessee's interest hereunder can be consistent with the name and identity of the holder of said Federal Communications Commission authorization. Any other assignment of this Lease by Lessee shall require Lessor's prior written consent, which consent shall not be unreasonably withheld.

20. **Environmental Warranty.** Lessor hereby represents and warrants to Lessee that Lessor has never generated, sorted, handled, or disposed of any hazardous waste or hazardous substances upon the Premises, and that Lessor has no knowledge of such uses historically having been made of the Premises or such substances historically having been introduced thereupon.

21. **Subordination.** Lessee agrees to subordinate this Lease to any mortgage or trust deed which may hereafter be placed on the Premises, provided such mortgagee or trustee thereunder shall inure to Lessee the right to possession of the Premises and other rights granted to Lessee herein so long as Lessee is not in default beyond any applicable grace or cure period, such assurance to be in a form reasonably satisfactory to Lessee.

22. **Notices.** Any notice, demand or communication which Lessor or Lessee shall desire or be required to give pursuant to the provisions of this Lease, shall be sent by registered or certified mail; and the giving of such notices shall be deemed complete upon mailing in a United States Post Office with postage charges prepaid, addressed as indicated below, or to such other address as such party may heretofore have designated.

**If to Lessor:**

Executive Director  
Charlottesville-U.Va.-Albemarle County Emergency Communications Center  
2306 Ivy Road  
Charlottesville, VA 22903

If to Lessee:

USCOC of Virginia RSA #3, Inc.

Attn: Real Estate Lease Administration

8410 West Bryn Mawr Ave.

Chicago, Illinois 60631

**23. Lessee's Personal Property.** All personal property placed upon the Premises by Lessee shall remain the sole and exclusive property of the Lessee, and may be removed by Lessee at any time, including upon the expiration or other termination of this lease or any extension hereof.

**24. Upon Expiration of this Lease.** Prior to the expiration or other termination of this Lease, Lessee may remove Lessee's building, antennas and lines. Upon thirty days' written notice prior to the expiration or other termination of this Lease, at Lessor's request, Lessee shall (i) remove any or all other personal property placed upon the Premises by Lessee, (ii) request that overhead utility lines and related appurtenances be removed from the utility easement and (iii) restore the Premises to its condition as of the original date of this Lease. In no event shall Lessee remove any improvements made to the Tower. Upon the expiration or other termination of this Lease, all improvements made by the Lessee on the Site shall revert to Lessor and shall be free from any encumbrance at the time of such reversion.

**25. Limitation of Lessor's Liability.** Lessor shall not be liable to Lessee for any damages whatsoever for any damage to Lessee's property located on the Premises, including but not limited to any equipment of Lessee installed on the Tower, or for any interference with, or any damage, injury, or loss to its operations, caused by fire, flood, wind, rain, snow, hail, ice, lightning, earthquake, or any other force of natural cause, or any accident not caused by and not within the control of the Lessor.

**26. Binding Effect.** All of the covenants, conditions and provisions of this Lease shall inure to the benefit of and be binding upon the parties hereto and their respective successors and assigns.

**27. Entire Agreement.** This Lease constitutes the entire agreement between the parties and supersedes any prior understandings or oral or written agreements between the parties respecting the within subject matter.

**28. Modifications.** This Lease cannot be modified except by a written agreement executed by both parties expressly stating that it seeks to modify this Lease.

COUNTY OF ALBEMARLE, VIRGINIA

Approved as to form:

BY: \_\_\_\_\_  
Jeffrey B. Richardson, County Executive

\_\_\_\_\_  
Albemarle County Attorney

COMMONWEALTH OF VIRGINIA  
COUNTY OF ALBEMARLE

The foregoing Tower and Ground Space Lease was signed, sworn to, and acknowledged before me on this \_\_\_\_ day of \_\_\_\_\_, 20\_\_\_\_, by Jeffrey B. Richardson, County Executive, on behalf of the County of Albemarle, Virginia.

\_\_\_\_\_  
Notary Public

My commission expires: \_\_\_\_\_

USCOC of Virginia RSA #3, Inc.

By: *J R P*  
Vice President

STATE OF ILLINOIS

COUNTY OF COOK

The foregoing Tower and Ground Space Lease was signed, sworn to, and acknowledged before me this 27<sup>th</sup> day of August, 2020, by Jack R. Phipps, Vice-President, on behalf of USCOC of Virginia RSA #3, Inc.

*Ellen M Groh*  
Notary Public

My commission expires: 1/22/2021



# ALBEMARLE COUNTY VIRGINIA

EMERGENCY COMMUNICATIONS

## SITE NAME: BUCKS ELBOW MOUNTAIN

7045 BUCKS ELBOW MOUNTAIN RD  
CROZET, VA 22932  
ALBEMARLE COUNTY



BUCKS ELBOW MOUNTAIN  
NB+C PROJECT # TBD  
BUCKS ELBOW  
MOUNTAIN RD  
CROZET, VA 22932  
ALBEMARLE COUNTY

REVISIONS			
REV	DATE	DESCRIPTION	BY



JOHN A. DAUGHTREY, P.E.  
VA PROFESSIONAL ENGINEER LIC #09102

**TITLE SHEET**

**T-1**

### SITE INFORMATION

PROJECT DESCRIPTION	PROPOSED INSTALLATION OF TELECOMMUNICATIONS TOWER AND RELATED EQUIPMENT
SITE ADDRESS	7045 BUCKS ELBOW MOUNTAIN RD CROZET, VA 22932
LATITUDE (NAD 83)	38° 06' 18.287N
LONGITUDE (NAD 83)	78° 44' 11.437W
GROUND ELEVATION	3139.27+ AUSSL
JURISDICTION	ALBEMARLE COUNTY
ZONING	AG (AGRICULTURAL GENERAL)
PARCEL ID	03300-00-0000101
PARCEL AREA	0.27+ ACRES
PARCEL OWNER	COUNTY OF ALBEMARLE HELMONT AVE RD CHARLOTTESVILLE, VA 22902
TOWER OWNER	ALBEMARLE COUNTY EMERGENCY COMMUNICATIONS CENTER 200 WYNDY RD CHARLOTTESVILLE, VA 22902
STRUCTURE TYPE	SELF-SUPPORT
HEIGHT OF STRUCTURE	150.0 AGL
ROD CENTER	140.0 AGL
OVERALL HEIGHT OF STRUCTURE	164.0 AGL
TOTAL LEASE AREA	10,000 SQ FT
POWER PROVIDER	DOM #1024 (25345 5-3112)
TELECO PROVIDER	TRC

### EMERGENCY INFORMATION:

ALBEMARLE COUNTY FIRE & RESCUE	(434) 296-5833
ALBEMARLE COUNTY SHERIFF'S OFFICE	(434) 922-4001

### PROJECT TEAM

GENERAL CONTRACTOR	MOUNTAIN VALLEY TOWER SERVICES MARK BOVALDS (909) 888-9273
--------------------	--

### VICINITY MAP

SCALE: 1" = 500'



### DIRECTIONS

FROM ALBEMARLE COUNTY EMERGENCY COMMUNICATIONS CENTER, DEPART EGG 10NWARD WYNDY ROAD, TURN LEFT ONTO US-29 SOUTH, EXIT RIGHT ONTO HEAVY TRAFFIC EXIT TOWARD CROZET, TURN LEFT ONTO YANCEY MILL RD, TURN LEFT ONTO HELLBROOK RD, RIGHT ONTO WYNDY RD, LEFT ONTO JARVIS GAP RD, TURN RIGHT ONTO CROZET RD, FOLLOW CROZET JARVIS GAP UP MOUNTAIN THREE MILES, TURN RIGHT TOWARD DATE ON BUCKS ELBOW MOUNTAIN RD, FOLLOW ROAD FOR ONE AND A HALF MILES, ARRIVE AT SITE ON THE RIGHT.

### CODE COMPLIANCE

ALL WORK AND MATERIALS SHALL BE PERFORMED AND INSTALLED IN ACCORDANCE WITH THE CURRENT EDITIONS OF THE FOLLOWING CODES AS ADOPTED BY THE LOCAL GOVERNING AUTHORITIES. NOTHING IN THESE PLANS IS TO BE CONSTRUED TO PERMIT WORK NOT CONFORMING TO THE LATEST EDITIONS OF THE FOLLOWING CODES

- 2012 INTERNATIONAL BUILDING CODE
- 2011 NATIONAL ELECTRICAL CODE
- 2009 NFPA 101 LIFE SAFETY CODE
- 2012 IFC
- AMERICAN CONCRETE INSTITUTE
- AMERICAN INSTITUTE OF STEEL CONSTRUCTION
- MANUAL OF STEEL CONSTRUCTION 13TH EDITION
- ANSI/A-222-G
- TIA 861
- INSTITUTE FOR ELECTRICAL & ELECTRONICS ENGINEER #1
- IEEE C92 NATIONAL ELECTRIC SAFETY CODE LATEST EDITION
- TELECOMDIA GR-125
- ANSI B311

### DRAWING INDEX

T-1	TITLE SHEET
Z-1	SITE PLAN
C-1	DETAILS & NOTES

### DO NOT SCALE DRAWINGS

THESE DRAWINGS ARE FORMATTED TO BE FULL-SIZE AT 24"X36". CONTRACTOR SHALL VERIFY ALL PLANS AND EXISTING DIMENSIONS AND CONDITIONS ON THE JOB SITE AND SHALL IMMEDIATELY NOTIFY THE DESIGNER/ENGINEER IN WRITING OF ANY DISCREPANCIES BEFORE PROCEEDING WITH THE WORK OR MATERIAL ORDERS OR BE RESPONSIBLE FOR THE SAME. CONTRACTOR SHALL USE BEST MANAGEMENT PRACTICE TO PREVENT STORM WATER POLLUTION DURING CONSTRUCTION.

### APPROVAL BLOCK

APPROVAL BLOCK



811  
 Know what's below.  
 Call before you dig.

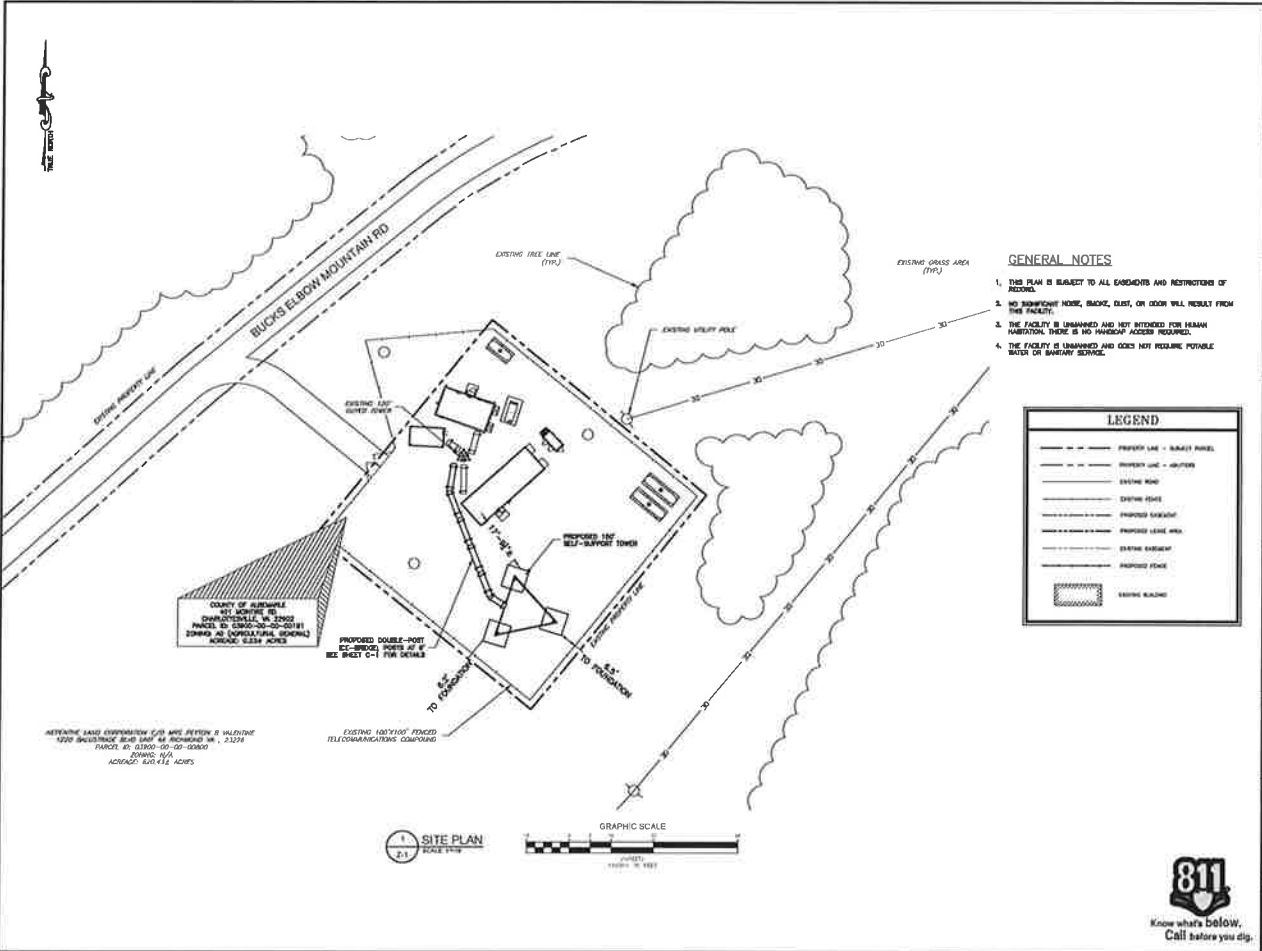

- GENERAL NOTES**
1. THIS PLAN IS SUBJECT TO ALL ORDINANCES AND RESTRICTIONS OF RECORDS.
  2. NO SUFFICIENT NOISE, SHOCK, DUST, OR ODOR WILL RESULT FROM THE FACILITY.
  3. THE FACILITY IS UNARMED AND NOT INTENDED FOR HUMAN HABITATION. THERE IS NO HAZARDOUS ACCESS REQUIRED.
  4. THE FACILITY IS UNARMED AND DOES NOT REQUIRE PORTABLE BARRIERS OR BARRIERS SERVICE.

**LEGEND**

	PROPERTY LINE - SUBJECT PARCEL
	PROPERTY LINE - ADJACENT
	EXISTING ROAD
	EXISTING ROAD
	PROPOSED DRIVEWAY
	PROPOSED LEASE AREA
	EXISTING DRIVEWAY
	PROPOSED DRIVEWAY
	EXISTING BLADING

METRIC SAID EQUIPMENT FOR THIS DESIGN IS VALIDATED  
 1200 BRIDGEVIEW ROAD UNIT 44 RICHMOND VA 23294  
 PARCEL ID: 03300-00-00-00000  
 ZONING: M-1  
 ACROSS: 6.0+1.2 ACRES



ENGINEER	 <b>TOTALLY COMMITTED</b> <small>NB+C ENGINEERING SERVICES, LLC          1000 UNIVERSITY DRIVE, SUITE 100          CHARLOTTE, NC 28202</small>												
APPLICANT	<b>ALBEMARLE COUNTY VIRGINIA</b> <small>2306 IVY ROAD          CHARLOTTEVILLE, VA 22903</small>												
SITE INFORMATION	<b>BUCKS ELBOW MOUNTAIN</b> NB+C PROJECT # TBD BUCKS ELBOW MOUNTAIN RD CROZET, VA 22832 ALBEMARLE COUNTY												
DESIGN RECORD	<table border="1"> <thead> <tr> <th colspan="3">REVISIONS</th> </tr> <tr> <th>REV</th> <th>DATE</th> <th>DESCRIPTION</th> </tr> </thead> <tbody> <tr> <td>1</td> <td>10/15/18</td> <td>Final Site Plan</td> </tr> <tr> <td>2</td> <td>10/15/18</td> <td>Issued</td> </tr> </tbody> </table>	REVISIONS			REV	DATE	DESCRIPTION	1	10/15/18	Final Site Plan	2	10/15/18	Issued
REVISIONS													
REV	DATE	DESCRIPTION											
1	10/15/18	Final Site Plan											
2	10/15/18	Issued											
PROFESSIONAL SEAL													
ENGINEER	JOHN A. DOUGHERTY, P.E. VA PROFESSIONAL ENGINEER LIC. 403213												
PROJECT TITLE	<b>SITE PLAN</b>												
SHEET NUMBER	<b>Z-1</b>												



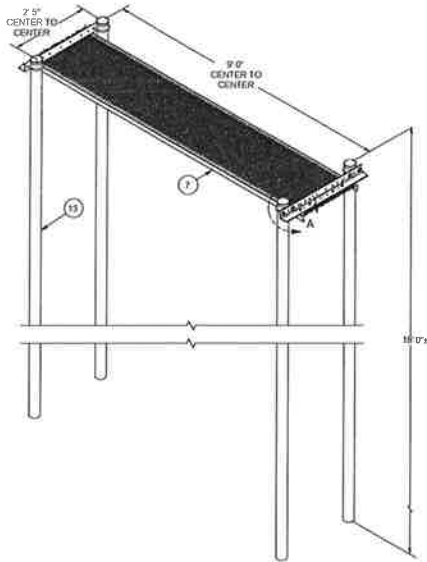

PARTS LIST						
ITEM	QTY	PART NO	PART DESCRIPTION	LENGTH	UNIT WT	NET WT
1	4	PC312	3-1/2" FENCE POST CAP		0.29	1.16
2	4	X-UB1359	1/2" X 3-5/8" X 5-1/2" X 3" U-BOLT (HDG.)		0.60	2.40
3	2	X-PP24	4-POST SUPPORT BRACKET	35.10 in	14.99	30.98
4	8	G12FW	1/2" HDG USS FLATWASHER		0.03	0.27
5	8	G12LW	1/2" HDG LOCKWASHER		0.01	0.11
6	8	G12ANJ	1/2" HDG HEAVY 2H-HEX NUT		0.07	0.57
7	1	G6B24	24" X 10 GRIP SPAN BRIDGE CHANNEL		67.38	67.38
8	4	SPLUC	SPLICE FOR GRIP STRUT	7.38 in	0.53	2.15
9	8	G303	3/8" X 3" HDG HEX BOLT GR3		0.12	0.97
10	8	G36FW	3/8" HDG USS FLATWASHER		0.01	0.09
11	8	G36LW	3/8" HDG LOCKWASHER		0.01	0.08
12	8	G36HUT	3/8" HDG HEAVY 2H-HEX NUT		0.01	0.27
13	4	P3126	2" SCH 40 PIPE (3" O.D. x 0.218" WALL) A500	216 in	1.36	5.45
					TOTAL WT. #	653.03

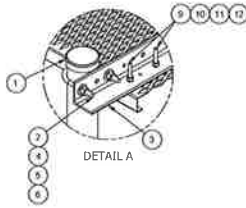
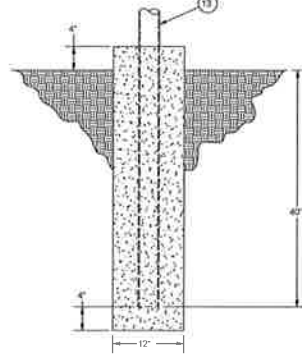
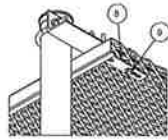

DIRECT BURIAL FOOTING

1 SITE-PRO 4B24D-216  
01

**NB+C**  
TOTALLY COMMITTED.  
NEC ENGINEERING SERVICES, LLC  
1400 WOODLAND DR. #100  
CHARLOTTE, NC 28207

---

**ALBEMARLE COUNTY VIRGINIA**  
2306 IVY ROAD  
CHARLOTTEVILLE, VA 22903

---

BUCKS ELBOW MOUNTAIN  
NBVC PROJECT # TBD  
BUCKS ELBOW  
MOUNTAIN RD  
CROZET, VA 22932  
ALBEMARLE COUNTY

---

REVISIONS

NO	DATE	DESCRIPTION	BY
1	02/24/16	FINAL SHEET	JDA
2	02/27/16	ISSUE FOR	JDA

---

PROFESSIONAL STAMP

---

ENGINEER  
JON A. DAUGHTREY, P.E.  
VA PROFESSIONAL ENGINEER LIC. #60213

---

SHEET TITLE  
**DETAILS & NOTES**

---

SHEET NUMBER  
**C-1**

COAX LENGTH	
TOTAL ICE BRIDGE LENGTH:	75-FT
ANTENNA CENTERLINE + 20-FT BUFFER:	122-FT
TOTAL ESTIMATED LENGTH OF COAX:	197-FT
TOTAL ESTIMATED LENGTH OF COAX (ROUNDED UP):	200-FT

JUMPER INFO	
3/4" JUMPER FROM COAX TO ANTENNA	
	LENGTH
ALPHA SECTOR:	10-FT
BETA SECTOR:	10-FT

PROPOSED LTE PANEL:   
 PROPOSED CDMA PANEL: 

**NOTES:**

1. PROPOSED TOWER HAS SUFFICIENT CAPACITY TO SUPPORT PROPOSED LOADING. SEE STRUCTURAL ANALYSIS REPORT BY TEP, DATED APRIL 25, 2019.
2. PROPOSED MOUNT REPLACEMENT HAS SUFFICIENT CAPACITY TO SUPPORT PROPOSED LOADING. SEE APPURTENANCE MOUNT REPLACEMENT ANALYSIS REPORT BY TEP, DATED MARCH 1, 2019.
3. PROPOSED FINAL ANTENNA LOADING TO BE CONFIRMED WITH USCC PRIOR TO CONSTRUCTION.
4. LIGHTNING ROD, TOWER LIGHTING, AND LADDER TO BE PROVIDED BY TOWER MANUFACTURER AND INSTALLED BY TOWER CONTRACTOR.

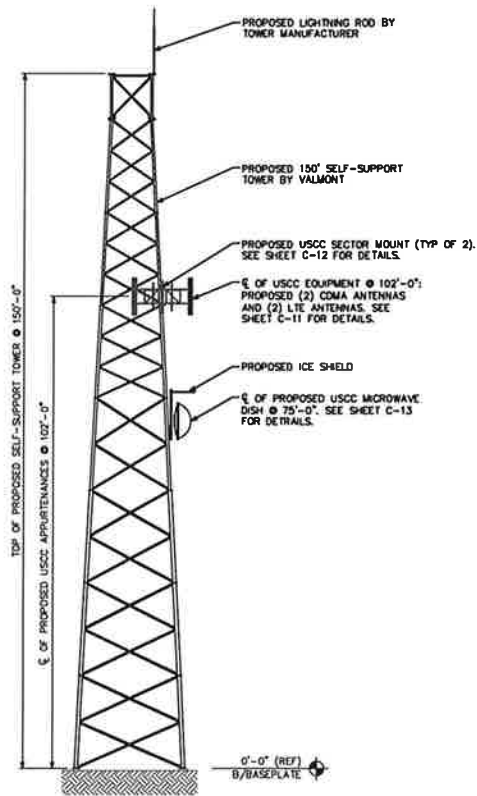

**PROPOSED TOWER ELEVATION**  
 SCALE: 1" = 20'

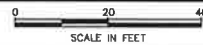

PLANS PREPARED FOR:  
**USCOC OF VIRGINIA  
 RSA #3, INC.**  
 8410 W. BRYN MAWR, SUITE 700  
 CHICAGO, IL 60631  
 (773) 399-8900

PROJECT INFORMATION:  
**768308  
 BUCKS ELBOW**  
 7045 BUCKS ELBOW MTN RD  
 GROZET, VA 22932  
 (ABLEMARLE COUNTY)

PLANS PREPARED BY:  
  
**TOWER ENGINEERING PROFESSIONALS**  
 328 TAYLOR ROAD  
 RALEIGH, NC 27603-3530  
 OFFICE: (919) 661-6351  
 www.teppro.com

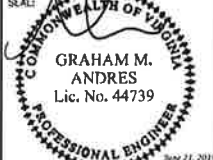
SCALE:  
  
**GRAHAM M.  
 ANDRES**  
 Lic. No. 44739  
 PROFESSIONAL ENGINEER  
 June 21, 2019

1.	06-21-19P	AGREEMENT/ISSUE
2.	03-26-19P	PRELIMINARY
3.	02-25-19P	PRELIMINARY
4.	02-19-19P	PRELIMINARY

REV DATE ISSUED FOR:

DRAWN BY: CWD CHECKED BY: LMM

SHEET TITLE:  
**PROPOSED TOWER  
 ELEVATION**

SHEET NUMBER: **C-5** REVISION: **5**  
 TEP # 44593.1250201